

General

Productgroup LF PowerOne SMD
 Mounting type SMT
 Material Brass lead-free (max. 0.1% Pb)
 Surface tin
 Customs tariff number
 Country of origin Federal Republic of Germany
 Weight per pieces ~ 0.001860 kg

Technical data

Terminal / Type blind hole / Metric
 Thread/Diameter x Length 3.000 mm x 4.50 mm
 Torque 0.50 Nm

Socket diameter 7.000 mm
 Socket height 6.50 mm
 Height total 6.50 mm

Processing

PCB thickness min. 1.00 mm
 Recommendation Solder cream thickness 150 μ m
 Notice

Current carrying capacity

Part (20°C) ~ / (85°C) ~ 70.000 A / 42.000 A

Usage and storage

Temperature -40°C up to +150°C
 Storage dry environment protected from weather conditions
 Storage conditions at +5°C up to +40°C, 75% RH, non-condensing

Packaging

packaging quantity 0.000 pcs

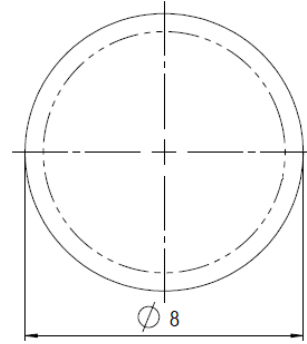
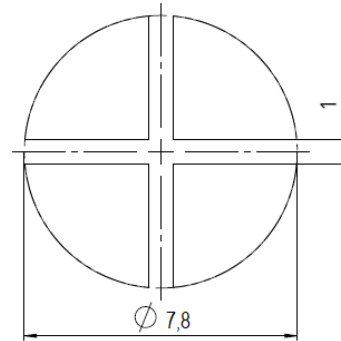
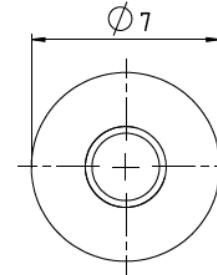
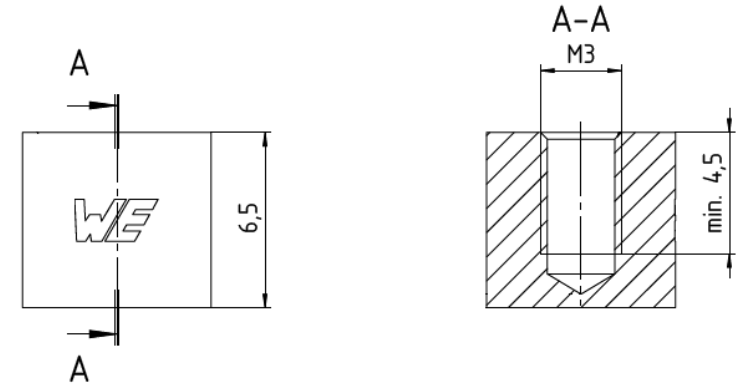
Solder pad recommendation**Stencil design recommendation****Dimensions**

Würth Elektronik ICS GmbH & Co. KG
 Würthstraße 1 74676 Niedernhall, Germany
 P +49 7940 9810-4444 lf-powerelement@we-online.de
 www.lf-powerelement.de

Observe protective note ISO 16016. Passing on or duplication without previous written agreement forbidden. Violations oblige to compensation. All rights reserved in the event of a patent or utility model protection. Subject to change without notice! Is NOT subject to change service!

General tolerances

DIN ISO 2768-mH

Projection mode



Revision	Date	All measures in
B	08.06.21	mm

Part no.

LF992003

Description

LF PowerOne SMD Bush vertical blind hole

